

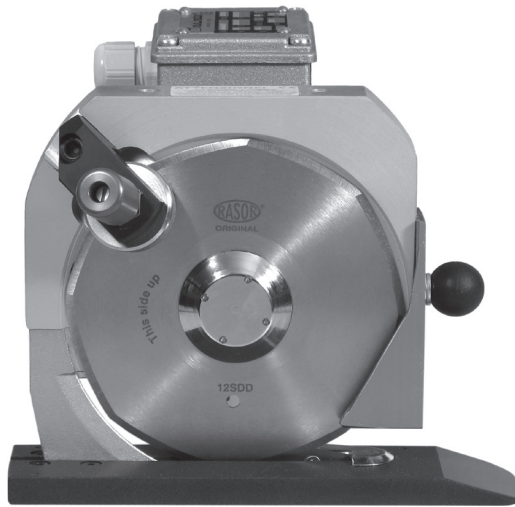

1946

DD120ML

THREE-PHASE
CUTTING UNIT



USE MANUAL

Rasor® Elettromeccanica S.r.l. was established in Milan in 1946 by Luigi Spinelli. For more than sixty years it has been producing automatic cutting systems, cutting units for textile applications and electric and pneumatic cutters.



Initially considered as a point of reference for cutting systems in the textile applications, the Rasor® products are nowadays widely used in other fields: chemical, automotive, nautical and sport sectors and in furniture manufacturing.

Nowadays Rasor® can rely on the professional continuity of two generations, with the experience inherited from the promoting partner, with his passion and dedication.

The main characteristic of Rasor® is that each working phase, starting from the manufacturing of the product up to its packing and delivery is carried out in Rasor® premises by qualified operators who have professionally grown up following the spirit of the company and of its founders. This ensures the high quality which Rasor® has always considered as essential since the beginning of its activity.

Following the innovative spirit mentioned above, our company is constantly focused on the improvement of the product quality, on the study and development of new materials and technologies.

ACKNOWLEDGEMENT

Dear Customer,

thank you for choosing a Rasor® Elettromeccanica S.r.l. product.

Rasor® has been a reference point in the field of cutting systems in the textile, clothing, furniture, tailoring, sport, chemical, automotive, nautical and insulating material sectors for years. Its production has been always synonymous with reliability attested by many of satisfied customers.

Rasor® quality system supervises all the company activities in order to provide the Customer with a service that meets its needs and expectations in terms of product quality, delivery reliability and stock of finished products.

All the parts of the devices have been planned and produced to guarantee an optimum performance. In order to keep the high quality level and the long reliability of the Rasor® products, it is recommended using only original spare parts and to contact the head office for any maintenance work.

1. GENERAL SAFETY RULES



This manual is an integral part of cutting unit DD120ML and must be carefully read before using it since it gives important indications with regards to its safe installation, use and maintenance. Keep it with care.



Before using cutting unit DD120ML, read carefully the following general safety rules.

- **PACKAGING.**
After taking off the packaging make sure that the cutting unit is intact. In case of doubt do not use it and contact an authorized service centre. Do not leave pieces of packaging (plastic bags, foam polystyrene, boxes, etc.) within the reach of children or disabled persons since they are potential sources of danger.
- **AVOID DANGEROUS ENVIRONMENTS.**
Prevent the cutting unit DD120ML components from coming in contact with damp or wet surfaces.
- **KEEP CHILDREN AWAY.**
Unauthorized persons, in particular children, must be kept away from the working area.
- **FEED CABLE.**
Prevent the feed cable from coming in contact with hot objects, pointed surfaces or sharp edges. Never pull the feed cable of the machine. It must never be replaced by the user. If necessary contact professionally qualified staff.
- **KEEP THE WORKING AREA ALWAYS IN ORDER.**
The workplace must always be kept in order and well lightened; liquids or oil traces must not be present.
- **ALWAYS USE CUTTING UNITS DD120ML PROPERLY.**
Use the cutting units only to carry out the works they have been designed for; do not use them improperly.
- **OBSERVE THE USE OF THE TOOLS.**
Do not cut excessively thick materials and always check blade conditions.
- **AVOID ACCIDENTAL STARTINGS.**
Before connecting cutting unit DD120ML, make sure that everything is installed properly.
- **CLOTHING.**
Do not use large clothes or accessories that might get stuck in the moving parts.
- **GOGGLES AND PROTECTIVE METAL MESH GLOVES.**
Always use goggles, protective metal mesh gloves approved by Rasor® during use and maintenance operations (according to UNI EN 388:2017 standard).
- **SPARE PARTS.**
During maintenance and replacement operations use only original spare parts. Blade maintenance must be only performed by Rasor® technicians.
- **INSTALLATION.**

Any installation that is not in conformity with these specifications could jeopardize your safety and cancels the warranty.

Informative letter

The installer and the maintenance man must know the content of this manual. Although the main features of the machine described in this manual are not subject to change, **Rasor® Elettromeccanica S.r.l.** reserves the right to modify the components, details and accessories it deems necessary to improve the machine or to meet manufacturing or commercial requirements at any time and without being obliged to update this manual immediately.

EN
4



WARNING



ALL RIGHTS ARE RESERVED ACCORDING TO THE INTERNATIONAL COPYRIGHT CONVENTIONS,

The reproduction of any part of this manual, in any form, is forbidden without the prior written authorization of Rasor® Elettromeccanica S.r.l.

The content of this guide can be modified without prior notice. Great care has been taken in collecting and checking the documentation contained in this manual to make it as complete and comprehensible as possible.

Nothing contained in this manual can be considered as a warranty, either expressed or implied - including, not in a restrictive way, the suitability warranty for any special purpose. Nothing contained in this manual can be interpreted as a modification or confirmation of the terms of any purchase contract.

Rasor® Elettromeccanica S.r.l. machines have not been conceived to work in areas at risk of explosions and at high risk of fire and they cannot cut wet or damp materials. Moreover, they cannot work in case of rain.

In case of damage or malfunction, cutting unit DD120ML must not be used until the Customer Care Technical Service has repaired them.

Customer Care Technical Service



For any information, please contact
RASOR® ELETTROMECCANICA S.r.l.
Via V. Caldesi, 6; 20161, MILANO (MI) - ITALY
Tel: +39.02.66221231; Fax: +39.02.66221293
e-mail: info@rasor-cutters.com
web: www.rasor-cutters.com

WARNING



The original configuration of the cutting unit must not be changed at all. On receiving the machine make sure the supply corresponds to what has been ordered. In case of non-compliance immediately inform Rasor®. Also make sure the cutting unit has not been damaged during transport.



2. TRANSPORT AND PACKING

The cutting unit is delivered in a cardboard box, inside which there are various options. The code of the ordered product and its serial number are indicated outside the package (see picture 1). The following accessories are contained in a bag inside the package:

- 1) Polygonal blade;
- 2) Butterfly wrench for blade nut disassembly;
- 3) Blade disassembly punch.

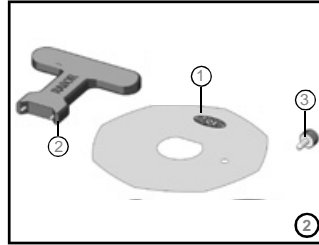

3. PLATE DATA

The manufacturer's identification and Machinery Directive 2006/42/EC conformity plate (see picture below) is located on the front part of the cutting unit.

The plate must not be removed at all, even if the machine is resold. Always refer to the serial number written on the plate itself when contacting the manufacturer.

Several safety warnings are printed on a card which is applied to the cutting unit feeding cable; such warnings must be strictly followed by everyone dealing with the machine. **The company is not to be held responsible for damage to property or accidents to people which might occur if the above-mentioned warnings are not observed. In such a case, the operator is the only person responsible.**

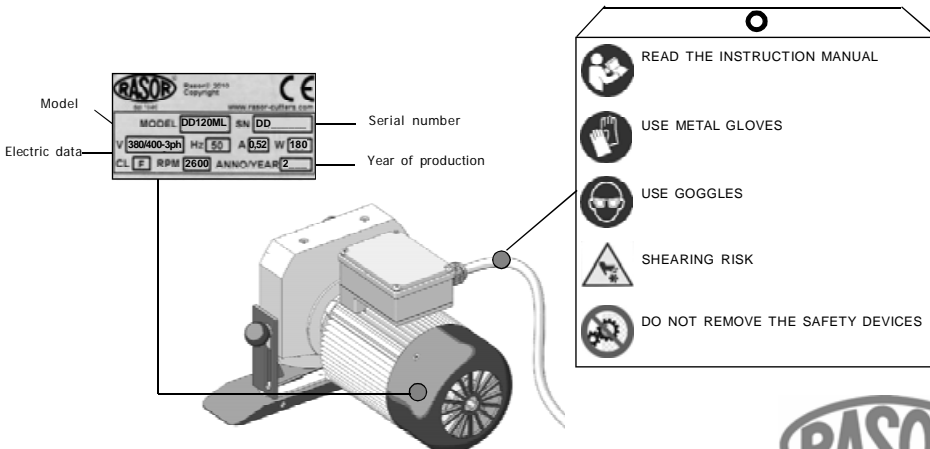

4. PRODUCT DESCRIPTION

EN
6

The fixture described in this manual is a cutting unit model DD120ML which can be assembled on automatic machines (e.g. spreaders, computerized cutting) by means of proper holes located in the motor rest. DD120ML can operate continuously and it can cut at various heights by means of multiple installation. The central upright of "Monster" type eliminates the winding problem of composite materials, that is the winding of fibres behind the blade. By cutting with the blade and the counterblade always in contact and thanks to the steel upper quality of the blade supplied, DD120ML guarantees the clean separation without fraying of the two borders of the cut material. The cutting time is halved and the material can slide at a doubled speed, thus reducing idle time. The three-phase motor, with extremely compact dimensions and extreme reliability with 120 mm diameter blades, guarantees cuts with thickness up to 4 cm. A sharpener assembled on the cutting unit head allows whetting the blade at any moment without disassembling it. After carrying out this operation, it is possible to start cutting again. A high power motor, perfectly balanced, with a high number of revolutions and totally free of maintenance, reduces the vibrations to the minimum, thus making the cutting unit comply with European Directive No. 2002/44/EC concerning the risks deriving from mechanical vibrations. The mechanical parts are made of high resistance steel, bronze and aluminium.

Device components			
1	Connector block	8	Hard metal counterblade coated with titanium
2	Motor frame	9	Poligonal blade
3	Feed cable	10	Monster type upright
4	Motor cover	11	Sharpening button
5	Adjusting knob protection cover	12	Emery wheel
6	Anodized aluminium front protection cover with adjustable height	13	Motor rest
7	Aluminium base covered with Teflon®	14	Cable gland

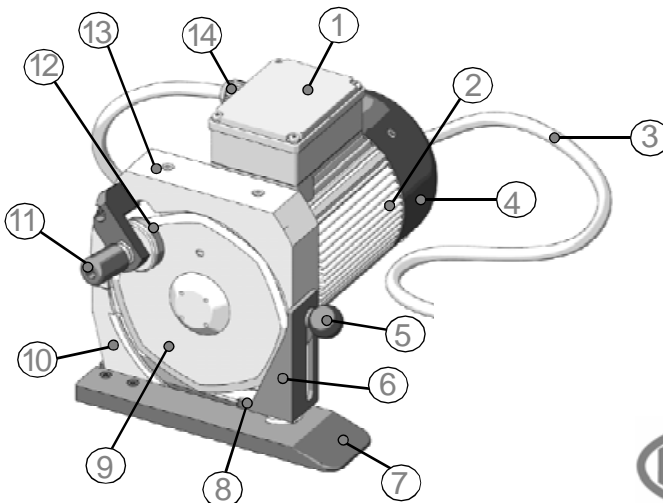

RASOR[®]

dal 1946

5. TECHNICAL FEATURES

DD120ML cutting unit features		Features of the available blades	
Blade diameter	120 mm with hard metal counterblade coated with titanium	12CDD	Circular blade Ø 120 mm, HSS Steel
Blade speed	2600 rev./min	12SDD	8 side blade Ø 120 mm, HSS Steel
Cutting working depth	about 4 cm		
Motor power	Three-phase-Asynchronous, 180 W (IP65-CL F)		
Max. absorption	0.52 A		
Weight (with feeding cable)	4800 g		
Weight (with package)	5000 g		
Electric cable length	1.5 mt		
Minimum light for working operations	LUX 200		
Vibration at the start up	$< 2.5 \text{ m/s}^2$		
Working temperature	0 ~ 55°C		
Working humidity	10 ~ 95% without condensate		

The technical data are only indicative and they can be changed without notice.

6. NOISE LEVEL

The maximum acoustic pressure level emitted by cutting unit DD120ML is about 60 dB (A). Noise tests have been carried out in compliance with Standard UNI EN ISO 11202:2010. The device noise levels, measured at different distances (without any sound wave filtering system), vary in the extent of few db (A).

NOTE

It is advisable for cutting unit DD120ML owners to verify the compliance with the standard concerning safety of workers: Italian legislative decree 81/08.

7. FIELD OF APPLICATION

Cutting unit DD120ML has been designed, manufactured and assembled to cut any kind of fabrics or materials, with the exception of metal, plastic or wood, by means of rotary polygonal blades. This equipment must not work:

- in areas prone to explosions;
- in presence of fine dust or corrosive gases;
- on wet or damp materials;
- to cut plastic, metal and wooden materials.

It is forbidden to use cutting unit DD120ML for purposes different from the above-mentioned ones.

8. USE WARNINGS

We recommend following the indications below in order to always work in safety conditions.

- All the operations must be carried out complying strictly with the safety rules of the country where the device is to be installed.
- It is STRICTLY FORBIDDEN to smoke during the installation or adjustment operations of the cutting unit.
- The Customer undertakes to comply with and make his staff observe all the rules and regulations in force concerning safety, prevention of accidents and health in the work place.
Therefore, the Customer assumes the responsibility to strictly follow all the rules and regulations in force, as well as the special provisions in force in sport and public installations the Customer declares to know after receiving all the relative necessary information.
- **The cutting unit works also without its safety protective device. This protective device must NEVER be removed.**
- Always check the resistance of the material to be cut and the kind of blade which is being used.
- The Customer shall equip his own personnel with all the individual safety protections for the execution of the works, as well as with the ones which might be prescribed by the Manufacturer due to specific danger conditions of the plant or of the area where the personnel must work.
- Do not make any adjustment while the blade is working or while the electric plug is connected.
- Always pay attention to the electric cable position to prevent it from being cut or damaged by the blade.
- It is allowed to assemble cutting unit DD120ML on machines O.E.M. on condition that their original structure is not modified. Otherwise, the intervention must be certified by Razor®.

9. ELECTRIC CONNECTION

Firstly make sure that the lines are able to feed the cutting unit correctly, in compliance with the safety rules (for the feature required see par. 5).

WARNING



We suggest installing a magnetothermic safety device before the cutting unit and check that the ground circuit is effective.

Before working on the feeding cable pull the plug out. Check that electric connections and protections correspond to the driving force and the plate data values (voltage and current), required by the different electric circuits.

By referring to the CEI 11-27/1 standard all the works carried out by means of electric current must be performed by a staff, who has been provided with all the devices required by the above-mentioned standard.

For the works carried out under voltage, it is necessary that the employer certifies the suitability, against formative processes. The cutting unit DD120ML is supplied with electric cable connected to the connector block located beside the motor.

The user must connect the cutting unit to the mains (the cable complies with the CEI 20-22 III Standard). Never change the length of the cable supplied. If it is necessary, use a longer cable and replace the one supplied.



To connect the new cable open the cover "A" by unscrewing the 4 cross-slotted screws "B" (see picture 3). Connect the phase cable to the terminal board. The minimum section of the connecting cables must be determined by the operator in charge of the installation.

We recommend using safety cables and sockets IMQ approved. Check the connection by enabling the cutting unit and verify the rotation direction. The cutting unit is provided with earthing (yellow-green cable). Possible faulty earthing connections may cause unsafe working conditions. Possible damages are not at RASOR® s.r.l. charge.

The electric feeding must be supplied by a line protected against overcurrent by means of the automatic switch (magnetothermal) or delayed fuses with a suitable dimensions. The current of the safety devices must be as low as possible considering the max. absorption of the machine (see identification plate).

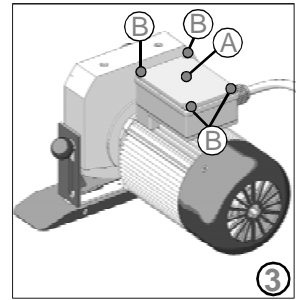

WARNING



The operator must arrange a disconnection switch on the supply line in order to switch off the machine, if necessary.

10. RESIDUAL RISKS

Even though the cutting unit is safe, operators must pay attention to preserve their and other people's safety.

- ⊗ At the end of the working operations, the metal parts could be very hot.
- ⊗ The cutting blade can work even when the protective device is disassembled.

11. INSTALLATION AND USE

To install and use the cutting unit, proceed as follows:

- 1) Fix the cutting unit on level squares or angles by using the two threaded holes "A" for M8 screws located in the blade holder support (see picture 4).

NOTE

The cutting unit can be installed in any position/angle: vertically, laterally and it can be turned upside down. It is not compulsory for the aluminium base to touch the machine table.

- 2) Lay the material to be cut;
- 3) Connect the cutting unit to the electric feeding;
- 4) Put the material on the cutting base;
- 5) Adjust the left mobile protection cover "B" according to the thickness of the material to be cut (see picture 5);
- 6) Carry out the cutting operation.

NOTE

Cutting unit DD120ML can work in a fixed position (the material has to be moved) or it can move forward while the material is kept in the same position. Make sure the material to be cut is properly stretched, preventing it from curling.

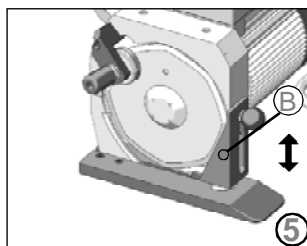
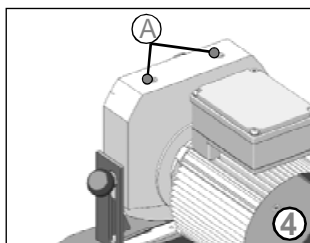

12. BLADE SHARPENING

After many hours of a continuative use of the cutting unit, or if it should not be able to cut anymore, it is necessary to sharpen the blade.

To carry out this operation, start the blade and press sharpener "2" located on it for 3-4 seconds (by pressing push button "1", as shown in picture 6).

Repeat the operation 2-3 times.

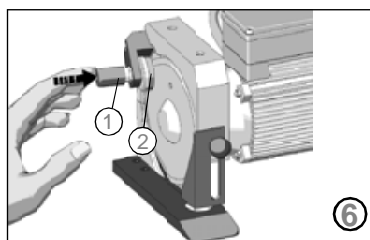

If the sharpening operation is not effective, check the wear of emery grinding wheel "3" (see picture 7). If emery grinding wheel "3" is too worn or dirty, replace it after disassembling the blade by means of the proper tool.

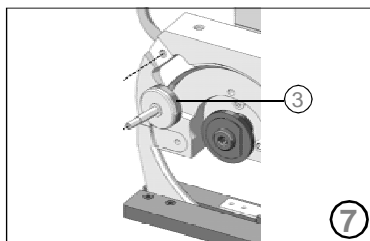

13. BLADE REPLACEMENT

If the blade is no more able to cut (even after repeating the sharpening operation several times) it is necessary to replace it. To carry out this operation, use butterfly wrench "1" and drift "3" locking the blade (shown in picture 8).

To replace the blade, proceed as follows:

- 1) Use some protective gloves in compliance with Italian Legislative Decree 81/08.
- 2) Remove the adjusting knob "A" of the left protection cover "C" by removing the two washers "B" (see picture 9).
- 3) Insert drift "3" into hole "D" (see picture 10), in order to lock the blade (the hole on the blade must correspond with the one on the structure).
- 4) Use butterfly wrench "1" to unscrew nut "E" and remove blade "F" (see picture 10).
- 5) Replace the worn blade with the new one "2", being careful to center the blade on the gear, in the correct position; we remind you to assemble it so that the side with the writing Rasor can be seen by the operator.
- 6) Assemble all the components again and carry out the sharpening.

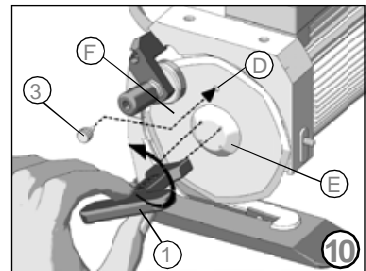
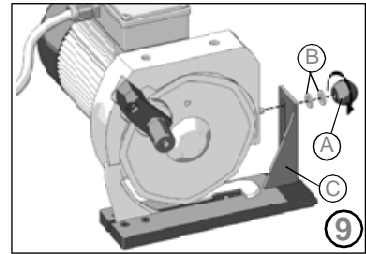
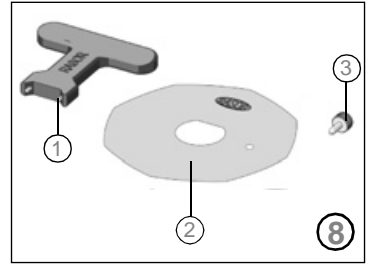

14. TROUBLESHOOTING

✘ PROBLEM

⇒ SOLUTION

The material is not cut or it gets stuck between the blade and the sliding foot

Make sure that the blade touches the sliding foot
Check the kind of material
Sharpen the blade
Check the material thickness
Check the compatibility between blade and material
Make sure that the motor turns correctly
Reduce the feeding speed

The cutting unit is noisy

Check the sliding foot integrity
Check the blade integrity
residues
Check the sliding foot integrity

The cutting unit starts slowly, works intermittently or it does not start

Check the electric connections on the O.E.M. unit
Check the electric connections
Check the feeding cable

15. SPARE PARTS / EXPLODED VIEW

CODE	DESCRIPTION	CODE	DESCRIPTION	CODE	DESCRIPTION	CODE	DESCRIPTION
12SD0	8 SIDE BLADE Ø 120 mm, IN H.S.S. STEEL	GRT12M28	COMPENSATION RING	SW109000	EMERY SPRING Ø 6 mm	SW124000	UPRIGHT SUPPORT SCREW
GMT12DD	COMPLETE MOTOR SERIES DD120, 3-ph 380 V 50 Hz	GRT12M29	FASTENING NUT	SW109100	SHARPENER CAP WITH BEARING	SW1244MDDL	LEFT ALUMINIUM PROTECTION COVER
GMT12DD48060	COMPLETE MOTOR SERIES DD120, 3-ph 480 V 60 Hz	GRT27	FLAME RETARDANT FEEDING CABLE	SW109200	SHARPENER CAP FIXING SCREW	SW1255MDDL	ALUMINIUM MOTOR SUPPORT
GRT1213DD	COMPLETE ROTOR SERIES DD120	GRT8615	SPACER	SW109300	WASHER	SW1261DD	HUB
GRT12DD24	COMPLETE MOTOR FRAME SERIES DD120	GRT8616	DOWEL FASTENING THE FAN	SW121100	STEEL PIN	SW126300	BLADE FIXING RING NUT
GRT12DD26	LOWER MOTOR FLANGE SERIES DD120	SW10765	SPRING WITH DOWEL	SW121400	ALLEN SCREWS FOR DD120 SUPPORT FIXING	SW1286DD	EMERY DD
GRT12M17	MOTOR FRAME FIXING SCREW	SW107900	COUNTERBLADE HOLDER FIXING SCREW	SW121600	L12 MOTOR BEARING	SW1286DDCPL	COMPLETE EMERY UNIT
GRT12M18	MOTOR COVER	SW108000	RIGHT COUNTERBLADE HOLDER	SW122100	SHAFT HEAD FIXING SCREW	SW1290M	RIGHT BASE WITH BEVEL, Monster
GRT12M19	MOTOR FAN	SW1081TN	RIGHT COUNTERBLADE COATED WITH TITANIUM	SW122300	STEEL STUD BOLT	SW1290MSCPL	COMPLETE BASE DD120ML
GRT12M21	UPPER MOTOR COVER	SW108200	COUNTERBLADE FIXING SCREW	SW122400	STEEL WASHER	SW129100	SHARPENER BUSH
GRT12M22	MOTOR COVER FIXING SCREW	SW108700	SHARPENER PIN	SW122500	PROTECTION COVER ADJUSTING KNOB	SW129200	SCREW FOR FIXING THE SHARPENER SUPPORT
GRT12M25	COMPLETE TERMINAL BOARD	SW108800	EMERY SPRING Ø 11 mm	SW12385	STEEL UPRIGHT	T107500	BLADE ASSEMBLING/DISASSEMBLING WRENCH
GRT12M27	UPPER MOTOR BEARING	SW108900	SHARPENER BUSH	SW1239DD	ALLEN SCREW FOR UPRIGHT FIXING	T1076DD	BLADE LOCKING PUNCH



dal 1946

WARRANTY

Rasor® Elettromeccanica S.r.l. cutting unit has a 12 month warranty from the date indicated on the last page of this manual, except in case of different written agreements.

The warranty covers all manufacturing and material defects. Replacement and repair operations are covered only if carried out by our company and at our workshop. If in-warranty goods need to be repaired, **the customer must always send the complete machine to Rasor®. Single units will not be repaired under warranty.**

The material to be repaired must be sent CARRIAGE FREE.

Once the machine has been repaired, it will be sent CARRIAGE FORWARD to the customer. The warranty covers neither technicians' intervention on site nor the machine disassembly from the installation place.

If for practical reasons, one of our technicians is sent to the premises, the customer will be charged the costs plus the travelling expenses.

The warranty does not include:

- ✎ failure caused by wrong use or assembly,
- ✎ failure caused by external agents,
- ✎ failure caused by lack of maintenance or negligence;
- ✎ blades and parts subject to wear.

WARRANTY FORFEITURE:

- ✎ In case of arrearage or other breaches of contract,
- ✎ Whenever changes or repairs are carried out on our cutting units without our prior authorization,
- ✎ Whenever the serial number is tampered with or cancelled,
- ✎ Whenever the damage is caused by improper use, bad treatment, bumps, falls and other causes not due to normal working conditions,
- ✎ Whenever the unit seems tampered with, dismantled or previously repaired by unauthorized staff,
- ✎ In case the cutting units are used for purposes that are different from the ones described in this manual.

All repair operations carried out under warranty do not interrupt its duration.

All disputes will be settled in the court of justice of Milan (Italy).

We thank you in advance for the attention you will pay to this manual and we invite you to inform us of any change you deem necessary to improve it and make it more complete.

RASOR ELETTROMECCANICA SRL

Via Vincenzo Caldesi 6

20161 Milan · Italy

ph. +39 02 66 22 12 31

fax +39 02 66 22 12 93

info@rasor-cutters.com

www.rasor-cutters.com

FOLLOW US:

